



STAR

QUALITY SWINGSETS



PREMIUM
VINYL
SWING SETS

About Us

For more than a decade, we have been handcrafting quality vinyl swingsets in Lancaster County, PA. Our family owned and operated business is fully committed to creating safe and durable swingsets for your children or grandchildren.

When you are looking for a playset for your child the last thing you need to worry about is safety. That's why at Star Quality we focus on safety. No exposed wood, which means no splinters, ever. Our rounded vinyl caps leave no dangerous sharp edges exposed. Non slip grip tape provides added traction on steps when entering the towers. Smooth, slip resistant vinyl is the only thing your child needs to come in contact with.

When it comes to durability, we believe in putting our money where our mouth is. That's why all our playsets have a no quibble, 20 year warranty. We believe in our product. That's why we guarantee you will too! See our warranty page for full details. Questions? Check out our FAQ's on page 16!

What are you waiting for? Shop our various playset models or start customizing your child's dream swingset today!

**Follow us for custom builds
and tips!**





STAR

QUALITY SWINGSETS



Table of Contents

4	The Best Value In Outdoor Play
5	FAQ
6	Star II
7	Star I
8	Star Cluster
9	Eclipse
10	Star Explorer
11	Shooting Star Climber
12	Silver Star
13	Solar
14	Starlight
15	Bright Star
16	Wishing Star
17	Stardust
18	Galaxy
19	Starburst
20	Comet
21	Galaxy Explorer
22	Moon Walk
23	Nebula
24	Playstation
25	Star Gazer
26	Orion's Hideout
27	Galaxy Star
28	Super Star
29	Space Shuttle
30	Lucky Star
32	Orbit Nebula Climber
33	Milky Way Climber
34	Free Standing Options
35	Options
46	Behind the Scenes
47	Photo Gallery

THE BEST VALUE

in Outdoor Playground Equipment



WE DELIVER AND INSTALL

Our trained crews will deliver and install your new swingset in your backyard. That means no more wasted weekends for you.



POLY CONSTRUCTION

Produced with plastic lumber made from high density polyethylene which would normally be disposed in our landfills.



8 DIFFERENT COLOR COMBOS

Available in colors that will blend into any backyard.



MAINTENANCE FREE

Our swingsets will not rust, rot or fall apart from wear. Poly and vinyl does not require staining or painting and are built to withstand harsh weather.



STAINLESS STEEL FASTNERS

We use high-quality stainless steel fasteners on all our swingsets, which are proven to be much more resistant to corrosion.



QUALITY ASSURANCE

All our swingsets are made using only the highest quality products, allowing us to stand behind our products knowing it will serve you well for years to come.



FAQ



Why is a vinyl swingset so much better than a traditional wood swingset?

By covering the wooden structural elements of the swingset, it keeps the stability without the maintenance. No one wants to restrain or repaint a swingset every year. Covering the wood also eliminates splinters. It also preserves the wood, helping our swingsets last for many fun-filled years.

What if my yard is not completely flat?

We can install on small slopes, however, we need to dig down/block up the tower to get it level.

How hard is it to maintain a vinyl swingset?

We love this question! Maintenance is all but unneeded. From time to time, as any outdoor toys do, your swingset will become dirty. Just use a simple cleaner and a soft bristled brush or gently powerwash the swingset.

Does the swingset get anchored into the ground?

The tower of the swingset is very heavy and does not require anchoring. We do use heavy duty spikes to anchor the ends of our swing beams to the ground.

Does it cost extra to customize?

No. The cost only changes as you add or take away components.

Can I pick my own colors?

Yes, you can mix and match colors as you choose.

Do your swingsets have any sharp edges?

No, to assure safety, all sharp edges are covered with a smooth rounded cap.

Do you have a warrenty?

Of course! Swingsets of this caliber carry a hefty warrenty! We offer a 20 year warrenty on our craftsmanship, while all of the accessories like slides, swings and roofs are covered by a 5 year warrenty. Please visit our website to learn more about our industry leading warrenties!

Star II

Vinyl Color: Tan
Trim Color: Red/Yellow
Tower: 3x3
Deck Height: 5'

Climbers: Entrance Ladder
Slides: 10' Wonder Wave
Swing Beam: 3 Position Single
Swings: (2) Belt Swings, Trapeze

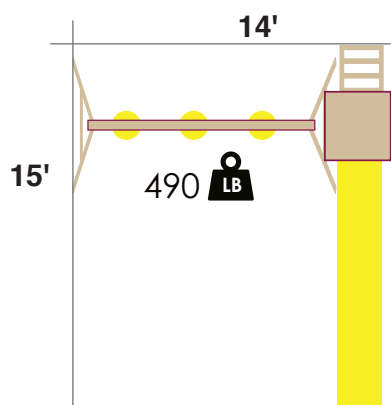

Border Needed:
24 pcs.
Rubber Mulch Needed:
2 Tons
Total Space Needed:
24' L x 24' W





Star ℓ

Vinyl Color: Tan
 Trim Color: Green
 Tower: 4x4
 Deck Height: 5'

Climbers: 5' Entrance Ladder, 5' Rockwall
 Slides: 10' Wonder Wave
 Swing Beam: 3 Position Single
 Swings: (2) Belt Swings, Trapeze

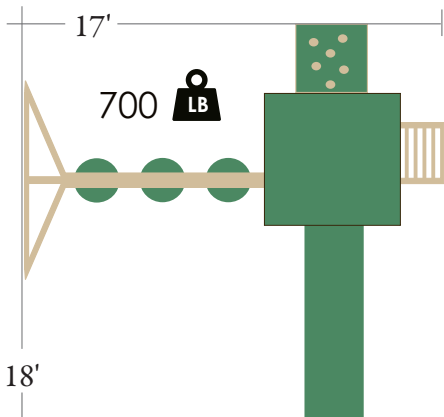

Border Needed:
 26 pcs.
 Rubber Mulch Needed:
 2.25 Tons
 Total Space Needed:
 24' L x 28' W



Don't need a sandbox? A second deck underneath the tower is a great option!



Star Cluster

Vinyl Color: White
 Trim Color: Green
 Tower: 4x4
 Deck Height: 5'
 Roof: 4x4 Vinyl

Climbers: 5' Entrance Ladder
 Slides: 10' Wonder Wave
 Swing Beam: 3 Position Single
 Swings: (2) Belt Swings, Highback
 Baby Swing

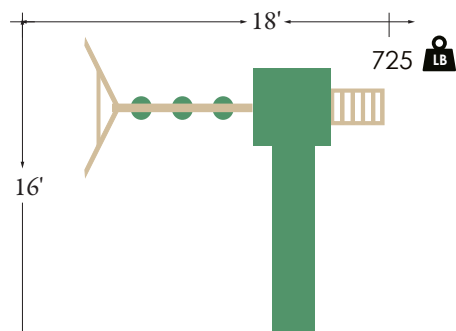

Border Needed:
 26 pcs.
 Rubber Mulch Needed:
 2.25 Tons
 Total Space Needed:
 24' W x 32' L



Adding a rockwall to the back of this set is a popular choice!

Eclipse

Vinyl Color: Tan
Trim Color: Green
Tower: 5x5
Deck Height: 5'
Roof: 5x5 Gable
Climbers: 5' Entrance Ladder,

Slides: 10' Wonder Wave
Swing Beam: 3 Position Single,
8' Monkey Bars
Swings: Belt Swing, Trapeze,
Safe-T-Glider w/ 4 Chain Adapter

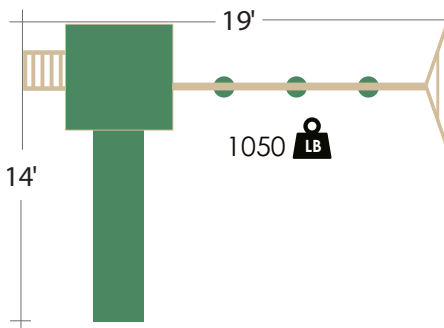

Border Needed:
28 pcs.
Rubber Mulch Needed:
2.5 Tons
Total Area Needed:
32' W x 24' L



Star Explorer

Vinyl Color: White
Trim Color: Gray
Tower: 5x5
Deck Height: 5'
Roof: 5x5 Vinyl
Climbers: Stairs with metal handrails

Slides: 10' Wonder Wave, 7' Spiral w/ Step and Slide Adapter
Swing Beam: 3 Position Single
Swings: Belt Swing, Trapeze, Safe-T-Glider with 4 Chain Adapter

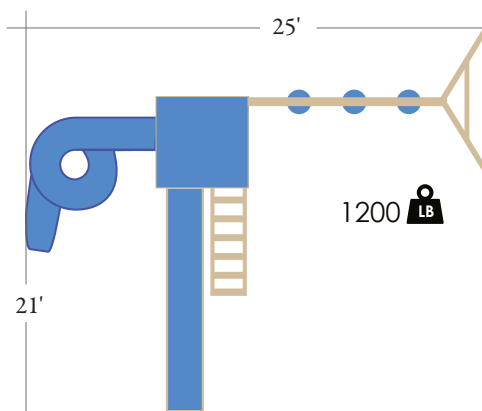

Border Needed:
26 pcs.
Rubber Mulch Needed:
2.5 Tons
Total Space Needed:
28' W x 24' L





Shooting Star Climber

Vinyl Color: White
 Trim Color: Blue
 Tower: 5x5
 Deck Height: 5'
 Roof: 5x5 Pyramid

Climbers: 5' Entrance Ladder, 5' Rockwall
 Slides: 10' Wonder Wave
 Swing Beams: 3 Position Monkey Bar
 Swings: (2) Belt Swings, Trapeze
 Add-Ons: Steering Wheel, Binoculars

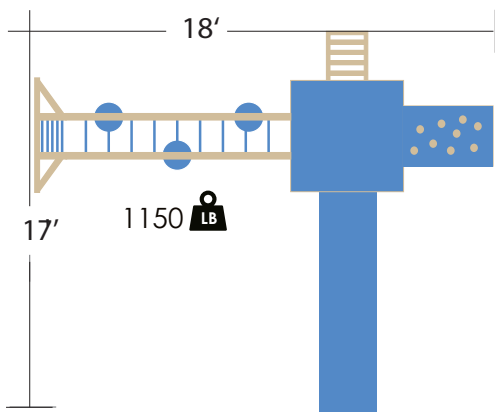

Border Needed: 24 pcs
 Rubber Mulch Needed: 2 Tons
 Total Space Needed: 24' W x 24' L



Do you want more slides? Add a 5' Spiral slide instead of the rockwall.



Silver Star

Vinyl Color: Tan
 Trim Color: Blue
 Tower Size: 4x6
 Deck Height: 5'
 Roof: 4x6 Vinyl

Climbers: 12' Ramp with Rope
 Slides: 10' Wonder Wave
 Swing Beams: 3 Position Single
 Swings: (2) Belt Swings, Highback
 Baby Swing

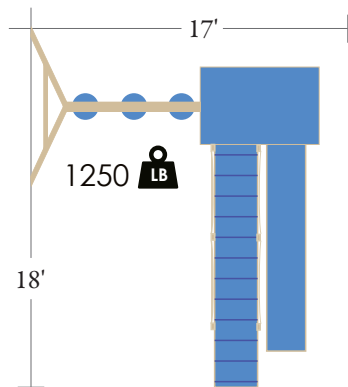

Border Needed:
 24 pcs.
 Rubber Mulch Needed:
 2 Tons
 Total Space Needed:
 24' W x 24' L



Don't forget your fun add-ons!

Solar

Vinyl Color: White
Trim Color: Blue
Tower Size: 4x6
Deck Height: 5'
Roof: 4x6 Vinyl

Climbers: 5' Entrance Ladder,
5' Rockwall
Slides: 10' Wonder Wave
Swing Beam: 3 Position Single
Swings: (2) Belt Swings, Baby Swing

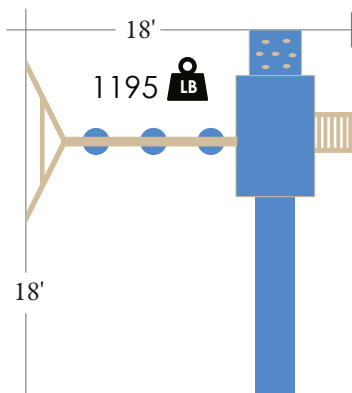

Border Needed:
26 pcs.
Rubber Mulch Needed:
2.25 Tons
Total Spcee Needed:
24' W x 28' L





Star Light

Vinyl Color: White
Trim Color: Gray
Tower Size: 4x6
Deck Height: 6'
Roof: 4x6 Vinyl
Climbers: 6' Entrance Ladder,
 6' Rockwall

Slides: 12' Avalanche, 6' Spiral
Swing Beams: 3 Position Single
 (extra high), Yardsaver Climber Unit
Swings: (2) Belt Swings, Baby Swing,
 Highback Baby Swing
Add-Ons: Ground Level Decking

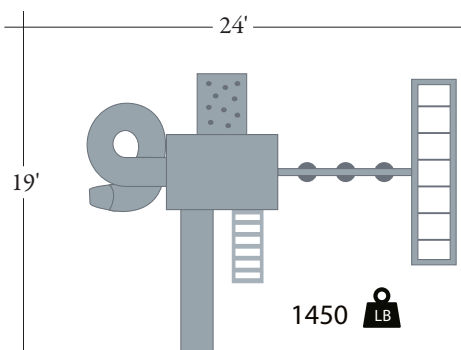

Border Needed:
 30 pcs.
Rubber Mulch Needed:
 3 Tons
Total Space Needed:
 32' W x 28' L





Bright Star

Vinyl Color: Tan
Trim Color: Green
Tower Size: 5x8
Deck Height: 5'
Roof: 5x5 Vinyl
Climbers: 5' Entrance Ladder
Slides: 10' Wonder Wave

Swing Beams: 3 Position Single
Swings: Trapeze, Full Bucket Baby, Safe-T-Glider w/ 4 Chain Adapter
Add-Ons: Ground Level Decking, 5' High Clubhouse, 5' Trading Post, Ships Wheel, Telescope

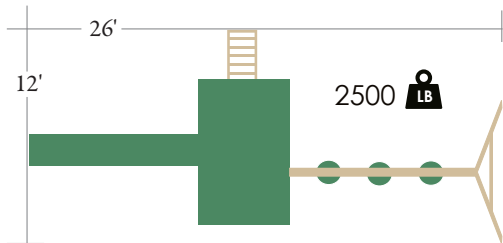

Border Needed:
 28 pcs.
Rubber Mulch Needed:
 2.5 Tons
Total Space Needed:
 36' W x 20' L



Add a few trading post chairs to make it unique!

Wishing Star

Vinyl Color: White
Trim Color: Green
Tower Size: 3x5 A-Frame
Deck Height: 5'
Roof: 3x5 Canopy Roof
Climbers: 5' Entrance Ladder,
 5' Rockwall

Slides: 10' Wonder Wave
Swing Beam: 2 Position Single, 1
 Position Extension Arm
Swings: (2) Belt Swings, Trapeze
 Tire Swing (under tower)

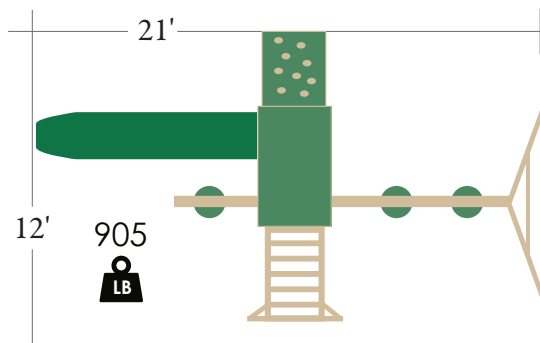

Border Needed:
 24 pcs.
Rubber Mulch Needed:
 2 Tons
Total Space Needed:
 28' W x 20' L

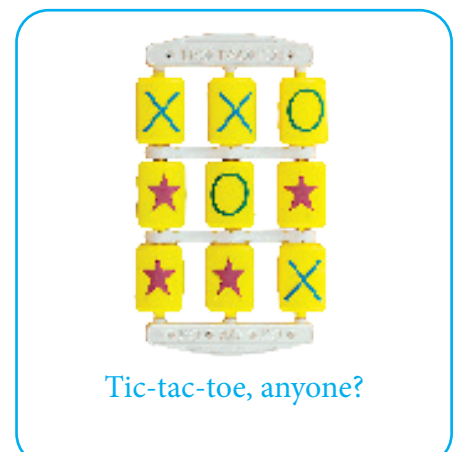



Stardust

Vinyl Color: Tan
Trim Color: Green
Tower Size: 5x5 A-Frame
Deck Height: 5'
Roof: 5x9 Canopy Roof

Climbers: 5' Entrance Ladder, 5' Cargo Net, 5' Rockwall
Slides: 10' Wonder Wave
Swing Beam: 2 Side Extension Arm
Swings: Belt Swing, Trapeze, Tire Swing (under tower)

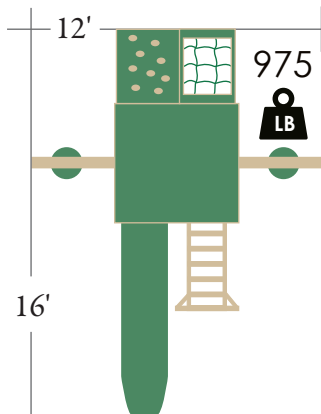

Border Needed:
 20 pcs.
Rubber Mulch Needed:
 1.5 Tons
Total Space Needed:
 16' W x 24' L





Galaxy

Vinyl Color: Tan
Trim Color: Green
Tower Size: 5x5 A-Frame
Deck Height: 5'
Roof: 5x9 Canopy
Climbers: 5' Entrance Ladder,
 5' Cargo Net, 5' Rockwall

Slides: 10' Wonder Wave, 5' Spiral
Swing Beams: 4 Position Single
Swings: (3) Belt Swings, Trapeze,
 Tire Swing (under tower)
Add-Ons: Ships Wheel, Binoculars

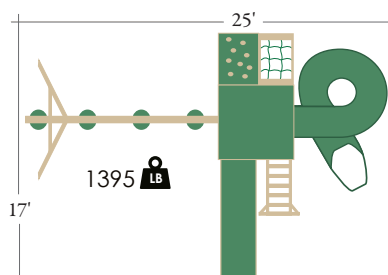

Border Needed:
 28 pcs.
Rubber Mulch Needed:
 2.5 Tons
Total Space Needed:
 32' W x 24' L



The Garden Bench is a great choice for parents and grandparents to sit and watch the fun.



Star Burst

Vinyl Color: White
Trim Color: Blue
Tower Size: 5x5 A-Frame
Deck Height: 5'
Roof: 5x9 Canopy
Climbers: 5' Entrance Ladder,
 5' Cargo Net, 5' Rockwall

Slides: 10' Wonder Wave
Swing Beams: 3 Position Monkey Bars
Swings: Belt Swing, Trapeze, Safe-T-Glider, Tire Swing (under tower)
Add-Ons: Ships Wheel, Telescope

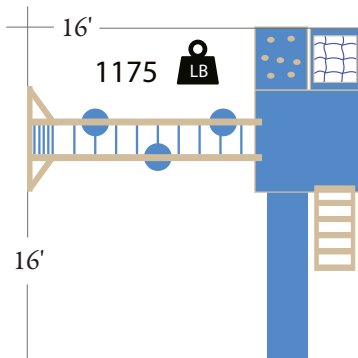

Border Needed:
 24 pcs.
Rubber Mulch Needed:
 2 Tons
Total Space Needed:
 24' W x 24' L





Comet

Vinyl Color: Tan
Trim Color: Blue
Tower Size: 5x5 A-Frame
Deck Height: 5'
Roof: 5x5 Vinyl
Climbers: 5' Entrance Ladder,
 5' Cargo Net, 5' Rockwall

Slides: 10' Wonder Wave
Swing Beam: 3 Position Single,
 8' Monkey Bars
Swings: (2) Belt Swings, Trapeze
 Tire Swing (under tower)

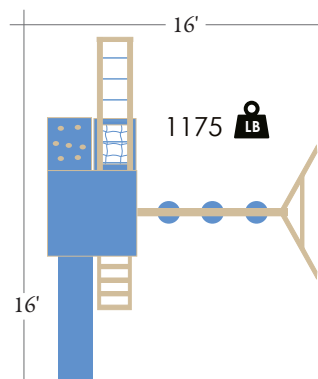

Border Needed:
 26 pcs.
Rubber Mulch Needed:
 2.5 Tons
Total Space Needed:
 24' W x 31' L



Visit our option pages in the back of the catalog to choose the perfect swings for your swingset!

Galaxy Explorer

Vinyl Color: White
Trim Color: Green
Tower Size: 5x5 A-Frame
Deck Height: 5'
Roof: 5x5 Pyramid
Climbers: 5' Entrance Ladder, 5' Cargo Net, 5' Rockwall

Slides: 10' Wonder Wave, 7' Spiral w/ Step and Slide Adapter
Swing Beam: 4 Position Single
Swings: Belt Swing, Trapeze, Safe-T-Glider w/ 4 Chain Adapter, Bouy Ball-Trapeze Combo, Tire Swing (under deck)

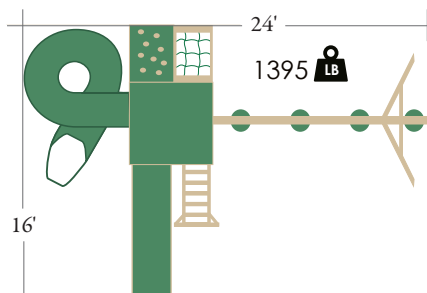

Border Needed:
30 pcs.
Rubber Mulch Needed:
2.5 Tons
Total Space Needed:
32' W x 24' L





Moon Walk

Vinyl Color: White
Trim Color: Gray
Tower Size: 3x5 A-Frame w/
 3x5 7' Deck
Deck Heights: 5' and 7'
Roofs: (2) 3x9 Canopy
Climbers: 5' Entrance Ladder,
 5' Rockwall

Slides: 14' Avalanche, 7' Spiral
Swing Beam: 3 Position Single
Swings: Belt Swing, Trapeze,
 Safe-T-Glider with 4 Chain Adapter,
 Tire Swing (under deck)

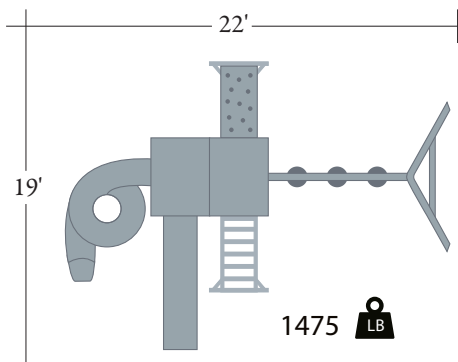

Border Needed:
 28 pcs.
Rubber Mulch Needed:
 2.75 Tons
Total Space Needed:
 28' W x 28' L



Nebula

Vinyl Color: White
Trim Color: Green
Tower Size: 5x5 A-frame w/
5x5 7' Deck
Deck Heights: 5' and 7'
Roofs: (2) 5x9 Canopy
Climbers: 5' Entrance Ladder,
5' Cargo Net, 5' Rockwall

Slides: 10' Wonder Wave, 7' Spiral
Swing Beam: 3 Position Single
Swings: (2) Belt Swings, Safe-T-
Glider with 4 Chain Adapter, Tire
Swing (under tower)

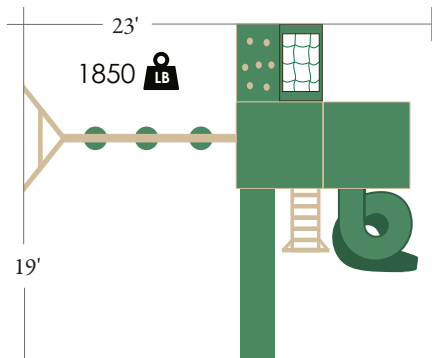

Border Needed:
28 pcs
Rubber Mulch Needed:
2.5 Tons
Total Space Needed:
32' W x 24' L



Add a spot for Mom or Dad underneath
the 7' high deck on the Nebula!



Play Station

Vinyl Color: Tan
Trim Color: Green
Tower Size: 5x8 Playhouse
Deck Height: 5'

Climbers: 5' Entrance Ladder
Slides: 10' Wonder Wave
Swing Beam: 3 Position Single
Swings: (2) Belt Swings, Trapeze

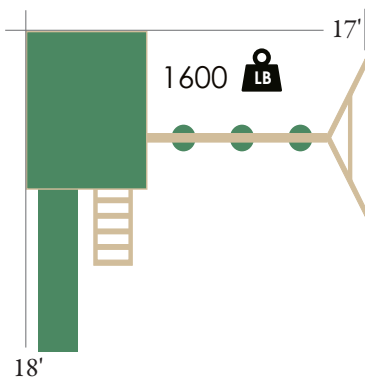

Border Needed:
 24 pcs.
Rubber Mulch Needed:
 2 Tons
Total Space Needed:
 24' W x 24' L



Star Gazer

Vinyl Color: White
Trim Color: Blue
Tower Size: 5x8 Playouse
Deck Height: 5'
Climbers: 12' Ramp with Rope

Slides: 5' Spiral
Swing Beam: 4 Position Single
Swings: Belt Swing, Trapeze, Baby Swing, Safe-T-Glider w/ 4 Chain Adapter

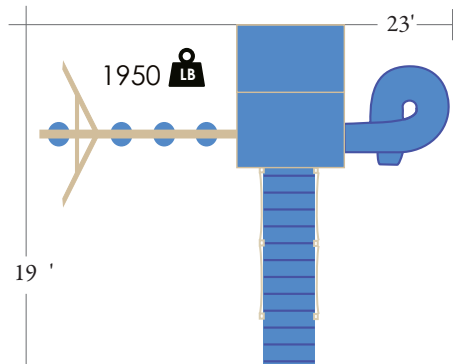

Border Needed:
28 pcs.
Rubber Mulch Needed:
2.5 Tons
Total Space Needed:
32' W x 24' L



Add a picnic table underneath the tower, a perfect place for snacks!



Orian's Hideout

Vinyl Color: Tan
Trim Color: Red
Tower Size: 8x8 Playhouse
Deck Height: 5'
Climbers: 5' Entrance Ladder, 5' Rockwall

Slides: 10' Wonder Wave, 5' Spiral, 7' Turbo
Swing Beam: 3 Position Single
Swings: (2) Belt Swings, Trapeze

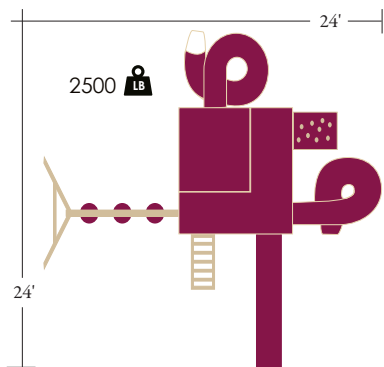

Border Needed:
 32 pcs.
Rubber Mulch Needed:
 3.5 Tons
Total Space Needed:
 32' W x 32' L



Galaxy Star

Vinyl Color: Tan
Trim Color: Red/Yellow
Tower 1 Size: 5x8 Double
Deck Height: 5' and 7'
Roof: 5x5 Vinyl
Tower 2 Size: 5x8 Playhouse
Deck Height: 5'

Connector: 6' 6" Bridge with Rails
Climbers: (2) 5' Entrance Ladders, 7' Rockwall
Slides: 10' Wonder Wave, 7' Spiral
Swing Beams: 3 Position Single
Swings: (2) Belt Swings, Baby Swing
Add-Ons: 5x5 Picnic Table

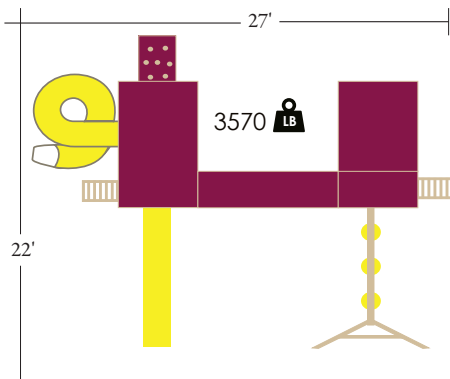

Border Needed:
 34 pcs.
Rubber Mulch Needed:
 4 Tons
Total Space Needed:
 36' W x 32' L





Super Star

Vinyl Color: Tan
Trim Color: Green
Tower Size: 5x8 Double
Deck Heights: 5' and 7'
Roof: 5x5 Pyramid
Climbers: 5' Entrance Ladder

Slides: 10' Wonder Wave, 7' Spiral
Swing Beam: 4 Position Monkey Bars
Swings: Belt Swing, Trapeze, Baby Swing, Safe-T-Glider
Add-Ons: Bubble Panel, Binoculars, Steering Wheel

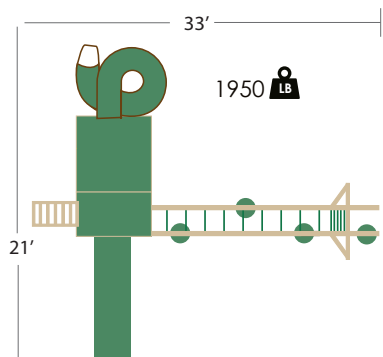

Border Needed:
 30 pcs.
Rubber Mulch Needed:
 3 Tons
Total Space Needed:
 28' W x 32' L



Lemonade, anyone? Add a trading post underneath the tower to let the sales begin!



Space Shuttle

Vinyl Color: White
Trim Color: Gray
Tower Size: 4x8 Double
Deck Height: 5' and 7'
Roofs: (2) 4x4 Vinyl
Climbers: Stairs, 7' Rockwall

Slides: 10' Wonder Wave, 7' Spiral
Swing Beams: 4 Position Single
Swings: (2) Belt Swings, Trapeze, Safe-T-Glider with 4 Chain Adapter
Add-Ons: Tic-Tac-Toe

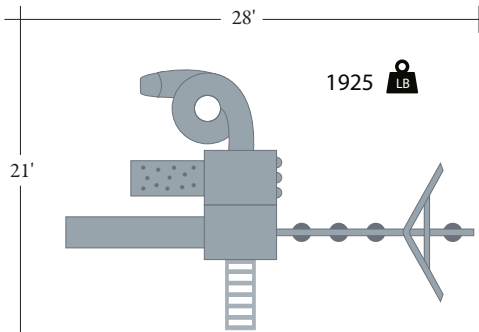

Border Needed:
 32 pcs.
Rubber Mulch Needed:
 3.25 Tons
Total Space Needd:
 36' W x 28' L





Lucky Star

Vinyl Color: White
Trim Color: Green
Tower 1 Size: 5x5 A-Frame with 5x5 7' Deck
Deck Height: 5' and 7'
Roofs: (2) 5x5 Vinyl
Tower 2 Size: 5x8 Double
Deck Heights: 5' and 7'
Roof: 5x5 Vinyl

Tower 3 Size: 5x5
Deck Height: 5'
Roof: 5x5 Vinyl
Connectors: 6' 6" Crawl Tunnel, 6' 6" Bridge with Rails
Climbers: (2) 5' Entrance Ladders, 12' Ramp w/ Rails, 5' Rockwall, 5' Cargo Net
Slides: 10' Wonder Wave, 7' Spiral, 7' Turbo, 5' Sidewinder



Swing Beams: Extra High 4 Position
 Single Beam, 3 Position Monkey Bars
Swings: (2) Belt Swings, Trapeze, Baby Swing

Border Needed:
 40 pcs.
Rubber Mulch Needed:
 5.25 Tons
Total Space Needed:
 44' W x 36' L

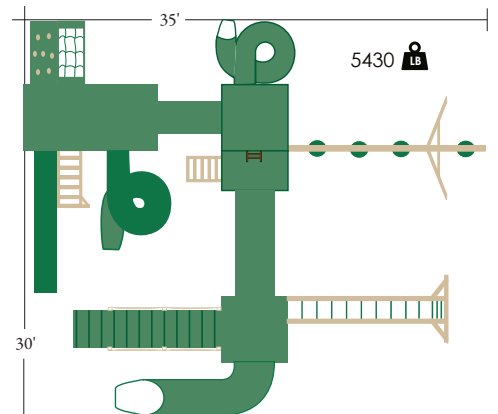



Orbit Nebula Climber

Vinyl Color: Tan
Trim Color: Green
Tower Size: 6x8 Triple
Deck Heights: 5' and 7'
Roof: 4x6 Vinyl
Climbers: 5' Entrance Ladder,
 5' Rockwall

Slides: 10' Wonder Wave, 7' Spiral
Swing Beam: 3 Position Monkey Bars
Swings: Belt Swing, Safe-T-Glider,
 Baby Swing

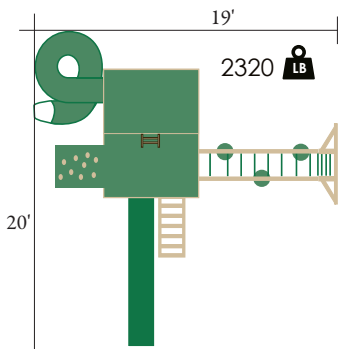

Border Needed:
 28 pcs.
Rubber Mulch Needed:
 2.75 Tons
Total Space Needed:
 28' W x 28' L



Milky Way Climber

Vinyl Color: White
Trim Color: Blue
Tower Sizes: (2) 5x8 Double
Deck Heights: 5' and 7'
Roofs: (2) 5x5 Pyramid
Slides: 10' Avalanche, 7' Spiral

Connectors: 6' 6" Crawl Tunnel, 6' 6" Bridge with Rope
Swing Beam: 3 Position Monkey Bars
Swings: Belt Swing, Highback Baby Swing, Safe-T-Glider with 4 Chain Adapter

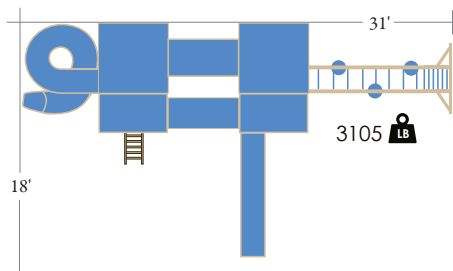

Border Needed:
 34 pcs.
Rubber Mulch Needed:
 3.75 Tons
Total Space Needed:
 40' W x 28' L



Add a Turbo or a Sidewinder slide to the back of either tower for more fun!

Free Standing Options For The Ultimate Playground!



**Free Standing
Swing Beam**
available in 2, 3 or
4 position lengths



**Fanback Lawn
Swing with Frame**
The perfect spot for
Dad and Mom!



4' Garden Bench



Guide To Building Your Own Swingset!

Step 1: Choose Your Colors!

Vinyl Colors



White



Tan



Green



Gray



Blue



Red

Trim Colors

Popular Color Combinations

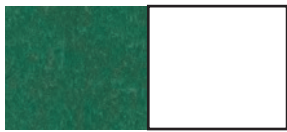

Green/White



Gray/White



Green/Tan



Blue/White



Guide To Building Your Own Swingset!

Step 2: Choose Your Tower Size!



3x3



4x4



4x6



5x5



4x8 Double



5x8 Double



6x8 Triple



3x5 A-frame



3x5 A-frame with
3x5 7' Deck



5x5 A-frame



5x5 A-frame with
5x5 7' Deck



5x8 Playhouse



8x8 Playhouse



Decking instead of Sandbox



Lower Deck Railing

Guide To Building Your Own Swingset!

Step 3: Choose Your Roof!

Which roof style is right for you? Canvas Roofs are more budget friendly, while vinyl roofs have the classic a-frame look and are handmade in our shop. Pyramid and Gable roofs have that classy feel.

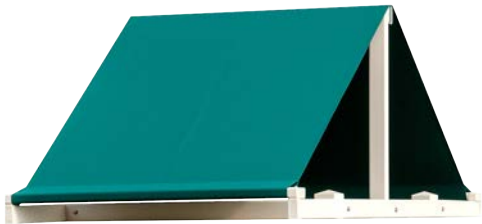

Canvas Roof

Use on 3x5 and 5x5
A-frame towers only



Vinyl Roof

3x3, 4x4, 4x6, 5x5

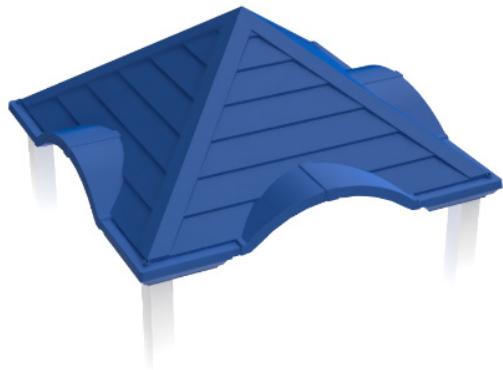

Pyramid Roof

4x4 or 5x5



Gable Roof

4x4 or 5x5



Guide To Building Your Own Swingset!

Step 3: Choose A Connecting Option!

Add a second tower with a connecting option, or you can also use swing beams to connect towers. If you are using a connecting option, just revert back to step 2 after choosing your connector! If you don't need a connector for your swingset, just skip this step!



6' 6" Bridge with Rails



6' 6" Bridge With Rope



6' 6" Crawl Tunnel



8' Wobbly Bridge



Guide To Building Your Own Swingset!

Step 4: Choose Your Access Options!



Entrance Ladder
Comes standard with
one handrail



**Stairs with
Metal Handrails**
5' deck height only.



Stairs with Railings



12' Ramp w/ rope
5' deck height only



12' Ramp w/ Railings
5' deck height only



Rockwall



Cargo Net



Tower Mounting Ladder
Attaches to tower to dismount
from monkey bars

Guide To Building Your Own Swingset!

Step 5: Choose Your Swing Beam!



2 Position Single Beam



3 Position Single Beam



4 Position Single Beam



2 Position Monkey Bars



3 Position Monkey Bars



4 Position Monkey Bars



1 Position Extension Arm



2 Position Extension Arm



Yardsaver Climber Unit

Guide To Building Your Own Swingset!

Step 6: Choose Your Slides!

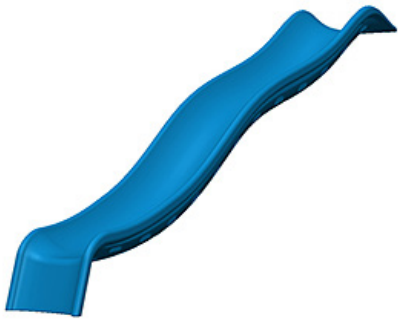

Wonder Wave Slide

5' deck height



Avalanche Slide

10'---for 5' deck height
12'---for 6' deck height
14'---for 7' deck height



Spiral Slide

5'---for 5' deck height
6'---for 6' deck height
7'---for 7' deck height



Turbo Slide

7'---7' deck height



Sidewinder Slide

5'---for 5' deck height
7'---for 7' deck height



Tunnel Express Slide

5'---for 5' deck height
7'---for 7' deck height



Clear Sections

Available for all tunnel slides



Step and Slide Adapter

Use to add any 7' deck slide to a 5' high deck

Guide To Building Your Own Swingset!

Step 8: Choose Your Swings!



Belt Swing



Trapeze Bar



Baby Swing



Highback Baby Swing



Safe-T-Glider

needs 4 chain adapter
when used on single beams

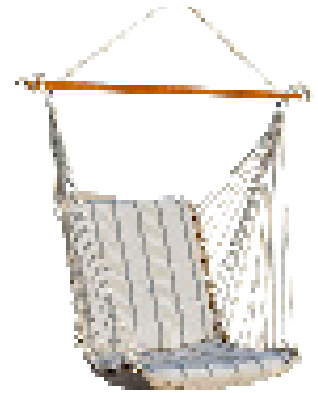

Hammock



4 Chain Adapter



Guide To Building Your Own Swingset!

Step 8: Choose Your Swings!



Bouy Ball



Buoy Ball/Trapeze



Web Swing



Swivel Tire Swing

for hanging under towers



Tire Swing For Beam

for hanging on swing beams

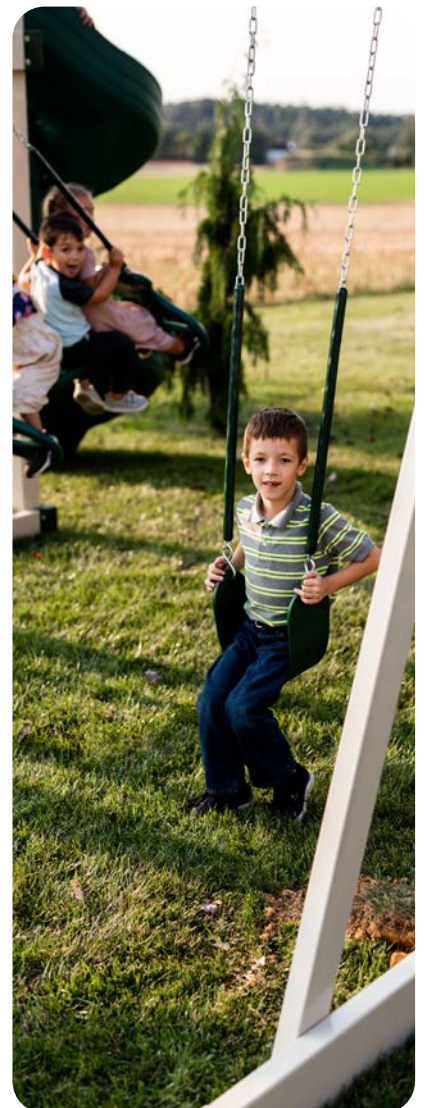

Guide To Building Your Own Swingset!

Step 9: Choose Your Fun Add-Ons!



Ships Wheel



Steering Wheel



Binoculars



Telescope



Spotlight



Megaphone



Tic-Tac-Toe



Picnic Table



Fireman's Pole



Bubble Panel



Trading Post



Swing Beam Misting System
Also available for slides!



Clubhouse under tower
5' high, 6' high, 7' high
Standard with 1 door and 2 windows



Trading Post Chairs
Sold by the pair

Guide To Building Your Own Swingset!

Step 10: Choose Your Finishing Touches!



Black



Green



Blue



Red



Brown

Recycled Rubber Mulch

- creates safer playgrounds
- extremely durable, does not decompose
- Does not attract insects
- 5 great color options
- dries exceptionally fast after rain
- mulch is 99.9% steel free

Flex-Wall Landscape Edging

- keeps the play area separate from the rest of the yard.
- looks like real stone
- made in Lancaster County, PA



Landing Pad

place under swings
or slides



Gray



Tan



Behind The Scenes

at Star Quality Swingsets



From our manufacturing facility,



to your backyard,

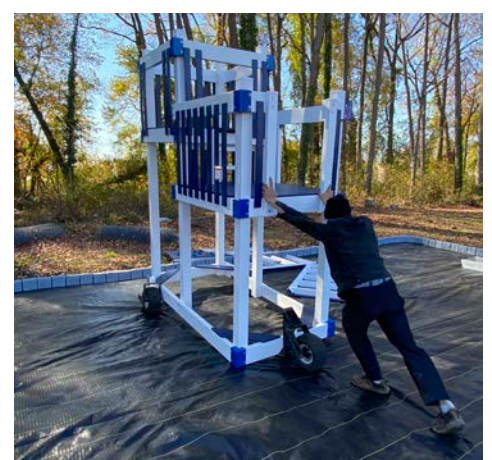
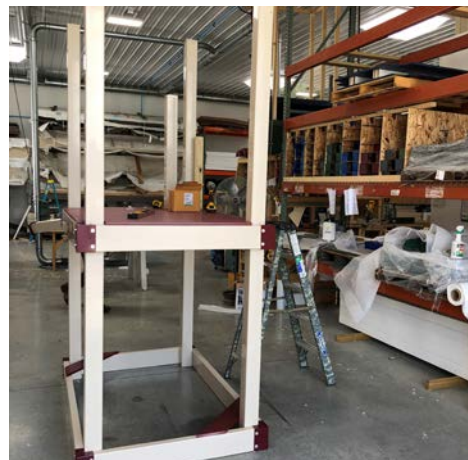

our dedicated crews will make sure you get the best swingset possible!

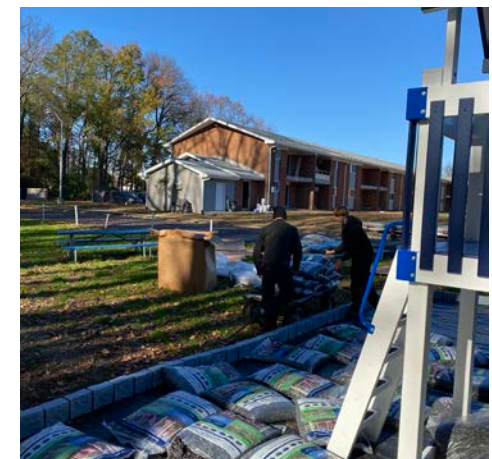

Customer Photo Gallery

Here is a small sample of some of the custom swingsets we have manufactured and installed over the years!





Your Authorized Dealer

2023 Star Quality Swingsets LLC All Rights Reserved. No part of thgis catalog may be reproduced in any form without the prior expressed written permission of Star Quality Swingsets LLC.